

1

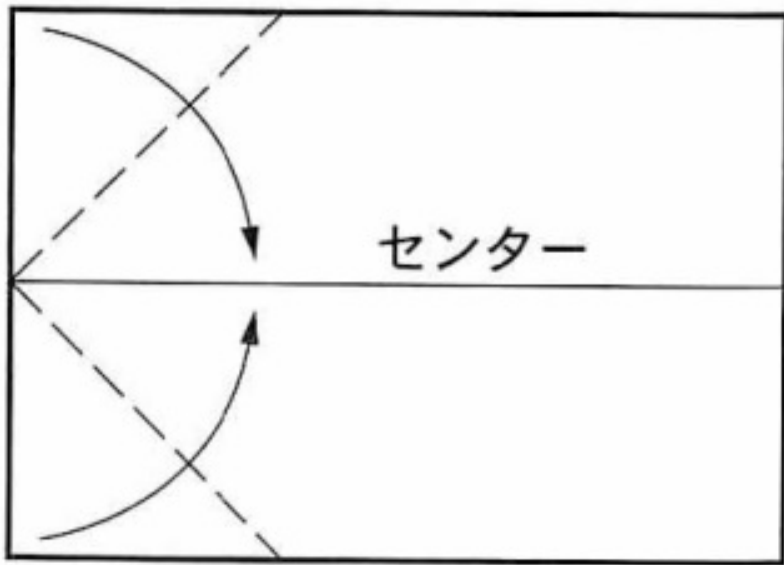

2

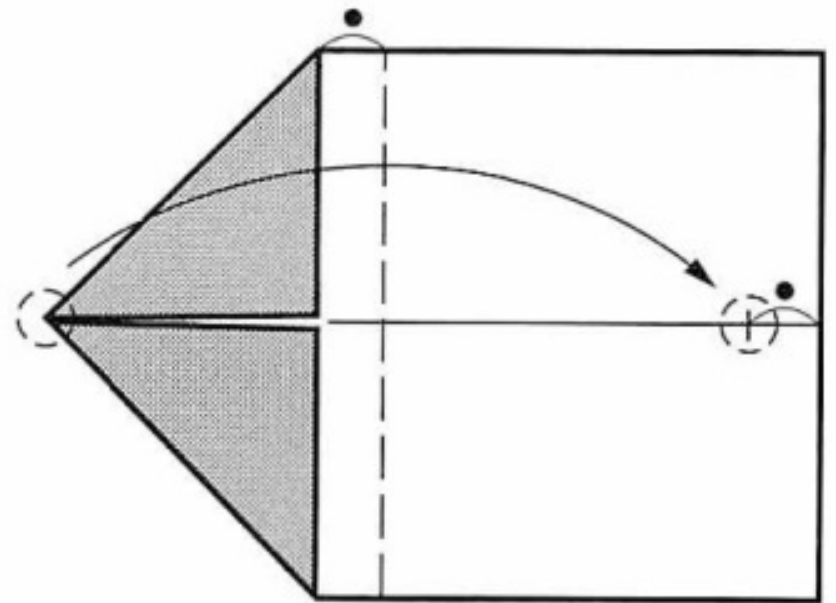

3

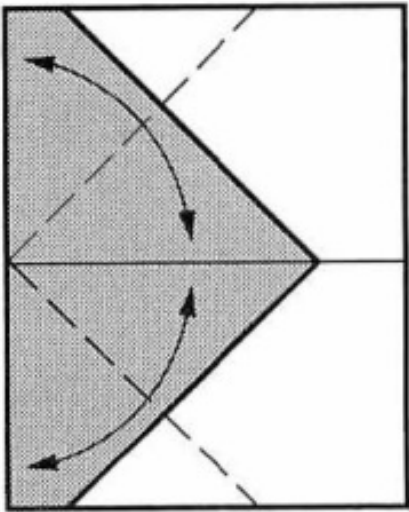

4

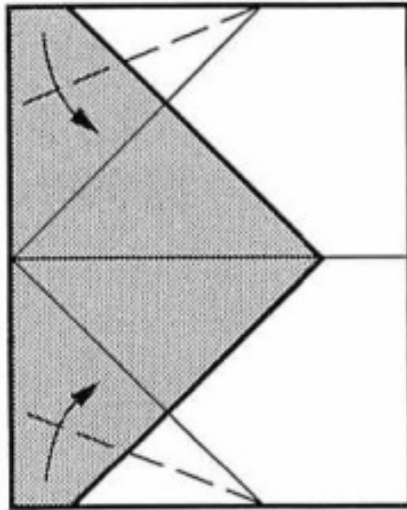

5

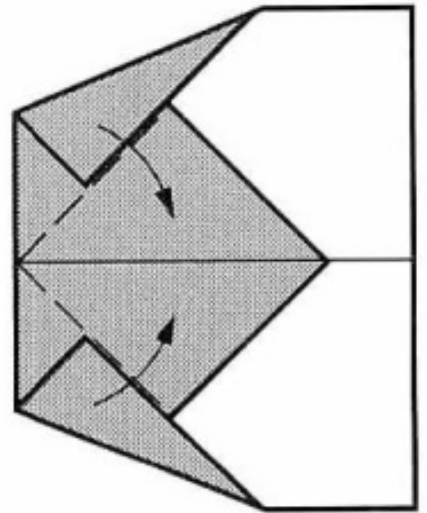

## 中心線で裏側に半分に折る

6

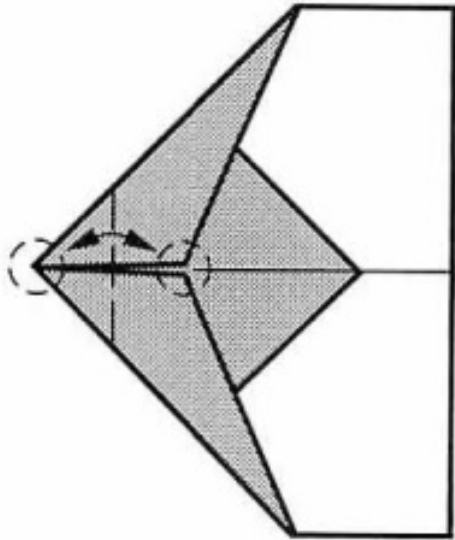

折った後、開く

7

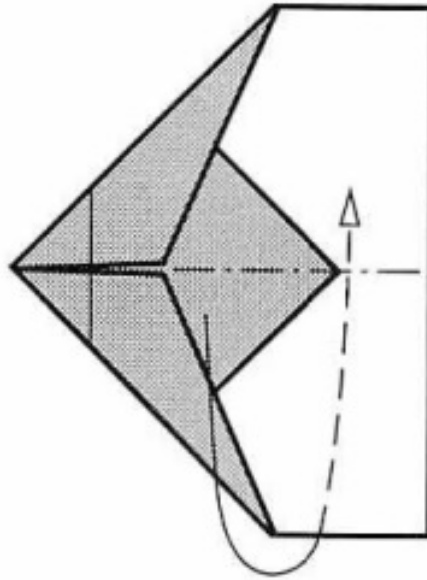

8

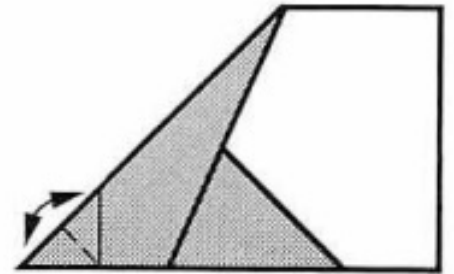

次の図を見て、  
中割り折りで先  
端を作る

9

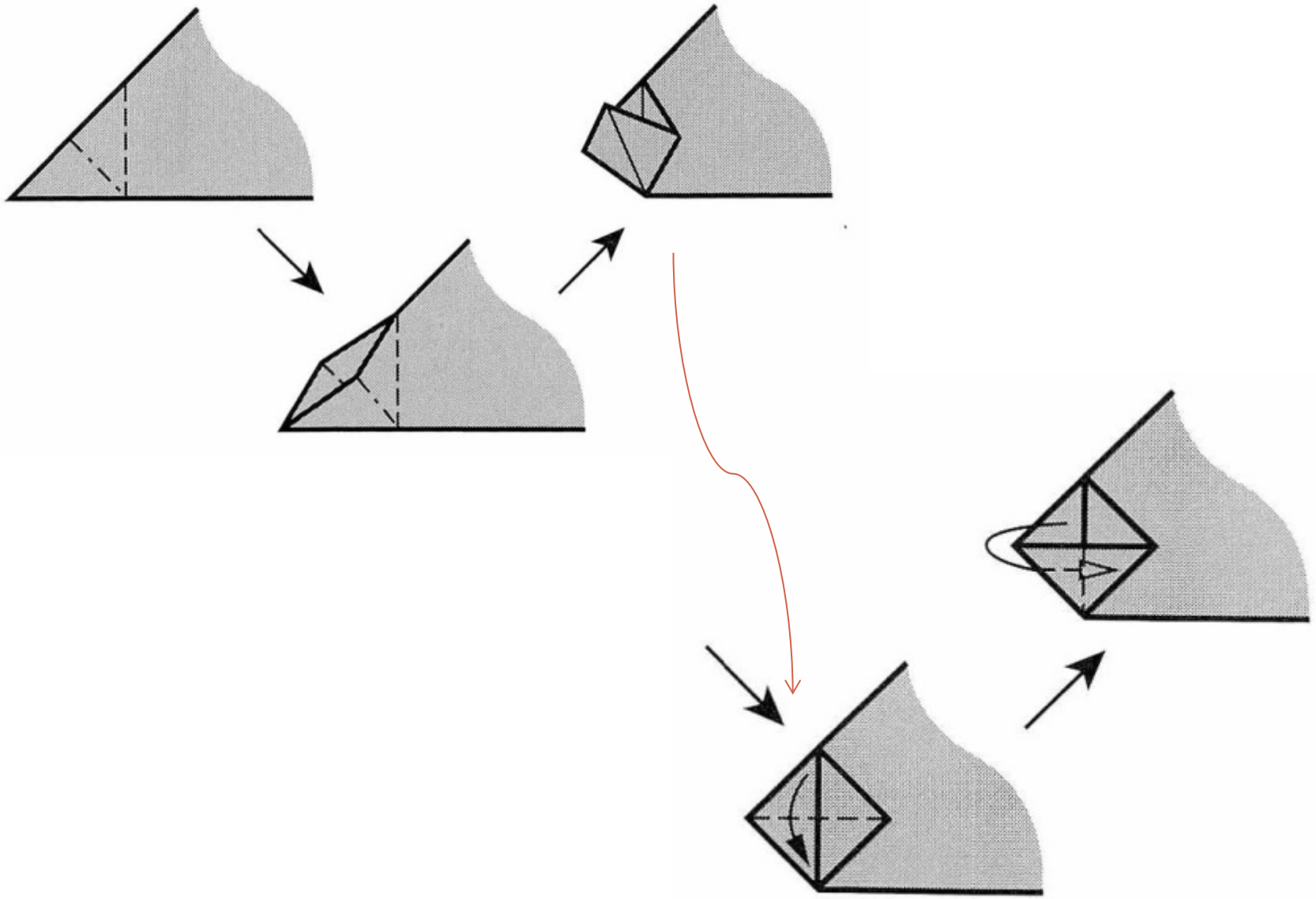

中割り折りで垂直尾翼  
を内側に折り込む

10

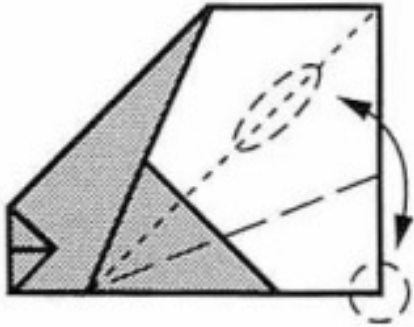

定規をあてて折る

11

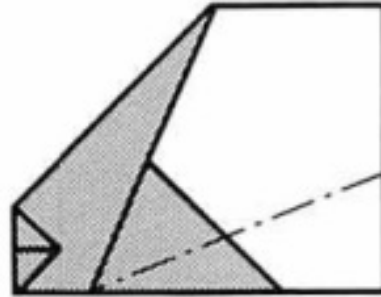

12

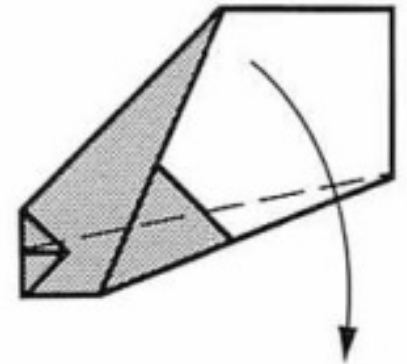

ラインに合わせて  
翼を折り返す

〈真上〉

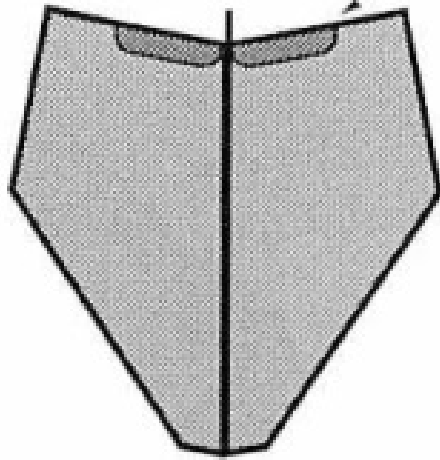

昇降舵  
(この線で上にひねる)

〈横〉

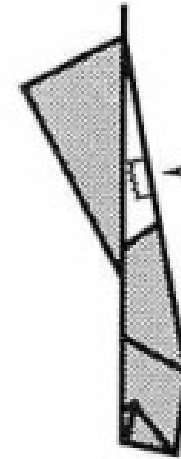

テープ

〈正面〉

